



Presenta



Lampade LED di sicurezza per l'industria

WELLED

LA RINNOVATA GAMMA
DI LAMPADE A LED

NIK
LED SECURITY
2015/05 welled-001



CE   
RoHS RAE CONFORMITY

WELLED

ILLUMINAZIONE A LED ALTAMENTE PERFORMANTE

Welled è la nuova famiglia di lampade a Led di **potenza** per un'illuminazione di qualità. L'ampia gamma di modelli standard **soddisfa le diverse esigenze** di luce nello spazio di lavoro: le lampade **Welled** sono ideali per macchine utensili, macchinari in genere, banchi da lavoro ed utlizzi vari, e sono **disponibili con diverse tipologie di alimentazione e gradi di protezione da IP20 a IP67**.



La **lunga durata nel tempo** è garantita grazie a **strutture solide e robuste** e tutti i Led sono fissati su supporti in alluminio per un'ottima dissipazione termica.

Il **risparmio energetico fino all'85%** rispetto a lampadine tradizionali, la **durata di oltre 40.000 ore** e la **bassa temperatura di esercizio**, le rendono molto interessanti per l'**abbattimento dei costi** e l'**aspetto ecologico**.



Sono state studiate con soluzioni ergonomiche per una **comoda e pratica orientabilità** del **flusso luminoso**: la maggior parte dei modelli con i bracci sono dotati di galletti e maniglia per facilitarne l'angolazione e la rotazione; le versioni tubolari, invece, sono provviste di supporti basculanti per una **precisa direzionabilità**.

Rispettano la parte applicabile delle Direttive 2006/95/CE, 2004/108/CE e 2006/42/CE, secondo le applicazioni previste dalla Normativa EN 1387.

LOFT
distribution

Sede legale: Via Brisa, 34 - 20015 Parabiago (MI) Italia - Sede operativa: Via Carnia, 2 - 20015 Parabiago (MI) Italia
E-mail: info@loft-srls.it Milo Frison cell. +39 349 1298839 P.IVA: IT 08421750962

WELLED

LA RINNOVATA GAMMA DI LAMPADE
A LED ALTAMENTE PERFORMANTI

NIK
LED SECURITY
2015/05 welled-001

CLIK LED



IP65
12W

24V-AC/DC 100÷240V-AC

ILLI LED



IP65
3W

24V-AC/DC 100÷240V-AC

PIK LED



IP20
3W

24V-AC/DC 100÷240V-AC

MINI-S LED SHORT



IP54
1W

3V-DC/350mA
24V-AC/DC 100÷240V-AC

MINI-F LED FIX



IP65
3W

24V-AC/DC 100÷240V-AC

MINI-Z LED ZOOM



IP65
3W

24V-AC/DC 100÷240V-AC

LEDY LED



IP67
7,5W-15W
22,5W

24V-DC

WIDE1 LED



IP67
20W
40W

24V-AC/DC 100÷240V-AC

CLIK LED

24V-AC/DC
100-240V-AC

12W
6.000°K 40.000 h

RoHS RAE CONFORMITY



IP65

NIK
LED SECURITY

2015/05

klik-001



CN12 L60-S-24ACDC
CN12 L25-S-24ACDC

CN12 L60-L/2-100240AC
CN12 L25-L/2-100240AC

CN 12 L60-M/2-24ACDC
CN12 L25/M/2-24ACDC



Snodi dotati di galletto per comodità di bloccaggio



Interruttore ergonomico on/off

ALTAMENTE PERFORMANTI

- ▣ Fino all'85% di risparmio energetico
- ▣ Basso calore
- ▣ Zero manutenzione
- ▣ Testa orientabile in alluminio estruso con vetro ad alta resistenza
- ▣ Bracci facilmente regolabili
- ▣ Resistente ai lubro-refrigeranti
- ▣ Direttive 2006/95/CE, 2004/108/CE e 2006/42/CE come previsto dalla Normativa EN 1387

LOFT
distribution

Sede legale: Via Brisa, 34 - 20015 Parabiago (MI) Italia - Sede operativa: Via Carnia, 2 - 20015 Parabiago (MI) Italia
E-mail: info@loft-srls.it Milo Frison cell. +39 349 1298839 P.IVA: IT 08421750962

CLIK LED IP65

24V-AC/DC
100÷240V-AC

12W
6.000°K 40.000 h

RoHS RAEE CONFORMITY



CLIK LED 24V-AC/DC, 12W

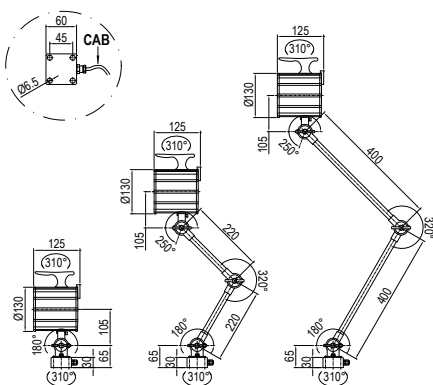

CN12 L60-S-24ACDC
CN12 L25-S-24ACDC
CN12 L60-M/2-24ACDC
CN12 L25-M/2-24ACDC
CN12 L60-L/2-24ACDC
CN12 L25-L/2-24ACDC

CLIK LED 100÷240V-AC, 12W

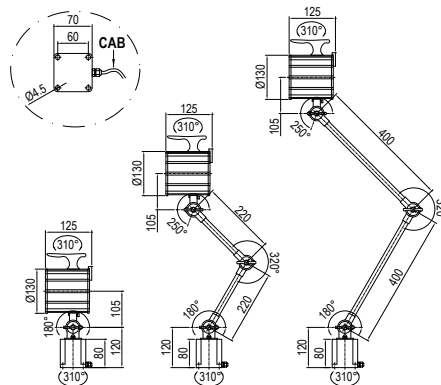

CN12 L60-S-100240AC
CN12 L25-S-100240AC
CN12 L60-M/2-100240AC
CN12 L60-M/2-100240AC
CN12 L60-L/2-100240AC
CN12 L25-L/2-100240AC

I DATI INDICATI NON SONO IMPERATIVI E POSSONO ESSERE MODIFICATI ANCHE SENZA PREAVVISO.

2 versioni di alimentazione:

- 24V-AC/DC con alimentatore integrato nella testa e cavo bipolare
- 100÷240V-AC con alimentatore integrato nella base e cavo con spina Schuko

Standard:

Modulo Led con angolo 60°
(25° in opzione)

Accessori opzionali:

vetri colorati, morsetti e staffa di fissaggio

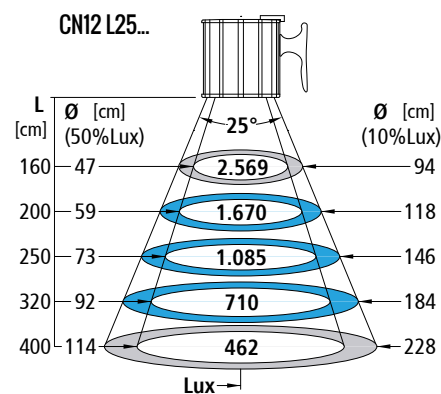
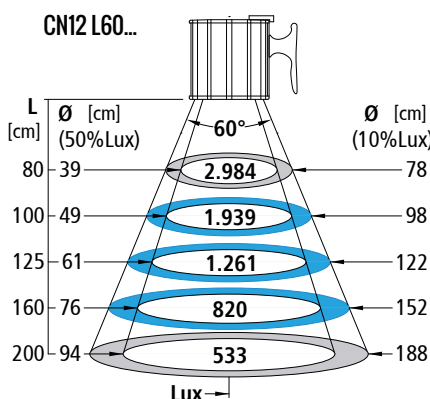

CLIK LED 24V-AC/DC

COD.	Vin	WxLed	CAB.mt	Kg
STANDARD: Modulo Led 60°				
CN12 L60-S-24ACDC	24V AC/DC	2Wx6	CV 02	1,80
CN12 L60-M/2-24ACDC			1,80	2,00
CN12 L60-L/2-24ACDC				2,40
OPZIONE: Modulo Led 25°				
CN12 L25-S-24ACDC	24V AC/DC	2Wx6	CV 02	1,80
CN12 L25-M/2-24ACDC			1,80	2,00
CN12 L25-L/2-24ACDC				2,40

CLIK LED 100÷240V-AC

COD.	Vin	WxLed	CAB.mt	Kg
STANDARD: Modulo Led 60°				
CN12 L60-S-100240AC	100÷240V AC	2Wx6	SP 02	2,00
CN12 L60-M/2-100240AC			1,80	2,20
CN12 L60-L/2-100240AC				2,60
OPZIONE: Modulo Led 25°				
CN12 L25-S-100240AC	100÷240V AC	2Wx6	SP 02	2,00
CN12 L25-M/2-100240AC			1,80	2,20
CN12 L25-L/2-100240AC				2,60

OPTIONAL E RICAMBI

VETRO NEUTRO

COD. FIL 109N

VETRO AZZURRO

COD. FIL 109A

VETRO GIALLO

COD. FIL 109G

MORSETTO CLIK 24V-AC/DC

COD. J C01

MORSETTO CLIK 100÷240V-AC

COD. J C02

STAFFA CLIK UNIVERSALE

COD. J L 01/02

ILLI LED

24V-AC/DC
100-240V-AC

3W
6.000°K 40.000 h

RoHS RAEE CONFORMITY



IP65

NIK
LED SECURITY
2015/05 illi-001



IN03 L30-F580-24ACDC
IN03 L45-F580-24ACDC
IN03 L30-F580-100240AC
IN03 L45-F580-100240AC

IN03 L30-L/2-24ACDC
IN03 L45-L/2-24ACDC
IN03 L30-L/2-100240AC
IN03 L45-L/2-100240AC

IN03 L30-S-24ACDC
IN03 L45-S-24ACDC
IN03 L30-S-100240AC
IN03 L45-S-100240AC



SU RICHIESTA: braccio flessibile 680mm



Lente intercambiabile con angolo 30° (standard) o 45° (in opzione)

ALTAMENTE PERFORMANTI

- ▣ Fino all'85% di risparmio energetico
- ▣ Basso calore
- ▣ Zero manutenzione
- ▣ Testa orientabile in alluminio estruso con vetro ad alta resistenza
- ▣ Bracci snodati facilmente regolabili o flessibili resistenti alle vibrazioni
- ▣ Resistente ai lubro-refrigeranti
- ▣ Direttive 2006/95/CE, 2004/108/CE e 2006/42/CE come previsto dalla Normativa EN 1387



Sede legale: Via Brisa, 34 - 20015 Parabiago (MI) Italia - Sede operativa: Via Carnia, 2 - 20015 Parabiago (MI) Italia
E-mail: info@loft-srls.it Milo Frison cell. +39 349 1298839 P.IVA: IT 08421750962

ILLI LED IP65

24V-AC/DC
100=240V-AC

3W
6.000°K 40.000 h

RoHS RAEE CONFORMITY



ILLI LED 24V-AC/DC, 3W

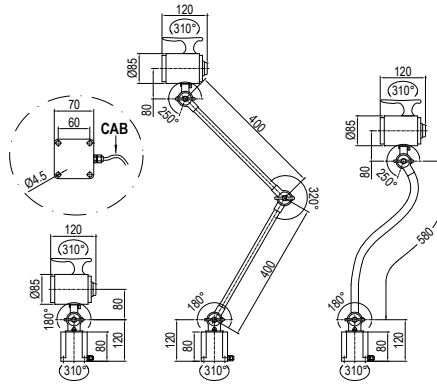

IN03 L30-S-24ACDC
IN03 L30-L/2-24ACDC
IN03 L30-F580-24ACDC *
IN03 L45-S-24ACDC
IN03 L45-L/2-24ACDC
IN03 L45-F580-24ACDC *

ILLI LED 100=240V-AC, 3W

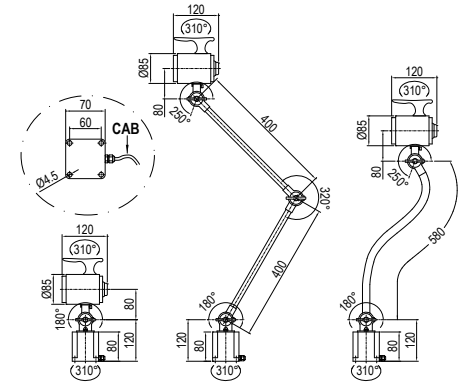

IN03 L30-S-100240AC
IN03 L30-L/2-100240AC
IN03 L30-F580-100240AC *
IN03 L45-S-100240AC
IN03 L45-L/2-100240AC
IN03 L45-F580-100240AC *

I DATI INDICATI NON SONO IMPERATIVI E POSSONO ESSERE MODIFICATI ANCHE SENZA PREAVVISO.

2 versioni di alimentazione:

- 24V-AC/DC con alimentatore integrato nella base e cavo bipolare
- 100=240V-AC con alimentatore integrato nella base e cavo con spina Schuko

Standard:

Lente con angolo 30° (45° in opzione)

Accessori opzionali:

vetri colorati, morsetto, staffa e base magnetica di fissaggio

* **SU RICHIESTA:**

braccio flessibile da 680mm "F680"

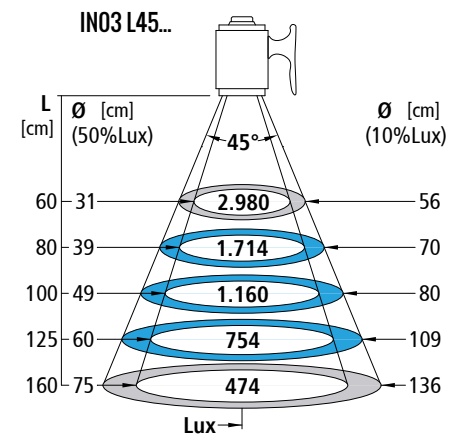
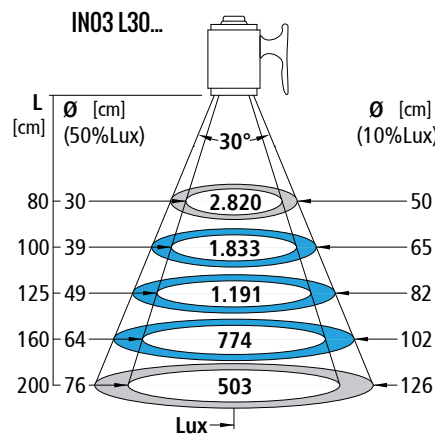

ILLI LED 24V-AC/DC

COD.	Vin	WxLed	CAB.mt	Kg
STANDARD: con Lente 30°				
IN03 L30-S-24ACDC	24V AC/DC	1Wx3	CV 02	1,70
IN03 L30-L/2-24ACDC			1,80	3,10
IN03 L30-F580-24ACDC *				2,70
OPZIONE: con Lente 45°				
IN03 L45-S-24ACDC	24V AC/DC	1Wx3	CV 02	1,70
IN03 L45-L/2-24ACDC			1,80	3,10
IN03 L45-F580-24ACDC *				2,70

ILLI LED 100=240V-AC

COD.	Vin	WxLed	CAB.mt	Kg
STANDARD: con Lente 30°				
IN03 L30-S-100240AC	100=240V AC	1Wx3	SP 02	1,70
IN03 L30-L/2-100240AC			1,80	3,10
IN03 L30-F580-100240AC *				2,70
OPZIONE: con Lente 45°				
IN03 L45-S-100240AC	100=240V AC	1Wx3	SP 02	1,70
IN03 L45-L/2-100240AC			1,80	3,10
IN03 L45-F580-100240AC *				2,70

OPTIONAL E RICAMBI

	LENTE 30°	LENTE 45°	VETRO NEUTRO	VETRO AZZURRO	VETRO GIALLO	MORSETTO	STAFFA	BASE MAGNETICA
COD.	LL-IN03-30°	LL-IN03-45°	FIL 65N	FIL 65A	FIL 65G	J C02	J L01/02	J M01

PIK LED

24V-AC/DC
100-240V-AC

3W
6.000°K 40.000 h

RoHS RAEE CONFORMITY



IP20

NIK
LED SECURITY

2015/05

pik-001



PNO3 L30-F680-24ACDC-W
PNO3 L45-F680-24ACDC-W
PNO3 L30-F680-100240AC-W
PNO3 L45-F680-100240AC-W

PNO3 L30-F580-24ACDC
PNO3 L45-F580-24ACDC
PNO3 L30-F580-100240AC
PNO3 L45-F580-100240AC



Lente intercambiabile con angolo 30° (standard) o 45° (in opzione)

ALTAMENTE PERFORMANTI

- ▣ Fino all'85% di risparmio energetico
- ▣ Basso calore
- ▣ Zero manutenzione
- ▣ Testa orientabile in tecnopolimero ed alluminio con vetro ad alta resistenza
- ▣ Bracci flessibili facilmente regolabili e resistenti alle vibrazioni
- ▣ Direttive 2006/95/CE, 2004/108/CE e 2006/42/CE come previsto dalla Normativa EN 1387

LOFT
distribution

Sede legale: Via Brisa, 34 - 20015 Parabiago (MI) Italia - Sede operativa: Via Carnia, 2 - 20015 Parabiago (MI) Italia
E-mail: info@loft-srls.it Milo Frison cell. +39 349 1298839 P.IVA: IT 08421750962

PIK LED IP20

24V-AC/DC
100÷240V-AC

3W
6.000°K 40.000 h

RoHS RAEE CONFORMITY



PIK LED 24V-AC/DC, 3W

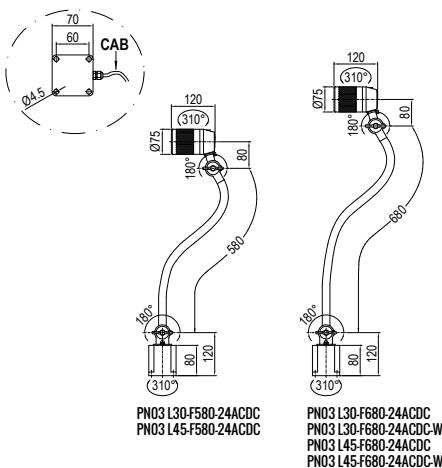

PIK LED 100÷240V-AC, 3W

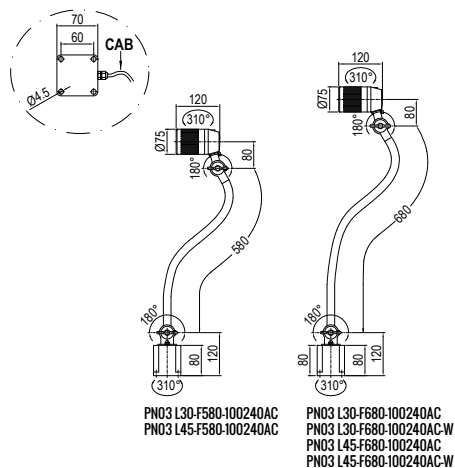

I DATI INDICATI NON SONO IMPERATIVI E POSSONO ESSERE MODIFICATI ANCHE SENZA PREAVVISO.

2 versioni di alimentazione:

- 24V-AC/DC con alimentatore integrato nella base e cavo bipolare
- 100÷240V-AC con alimentatore integrato nella base e cavo con spina Schuko Standard:

- colore esterno: nero per modelli con braccio 580mm/680mm; bianco (-W) per modello con braccio 680mm
- lente con angolo 30° (45° in opzione)

Accessori opzionali:

vetri colorati, morsetto, staffa e base magnetica di fissaggio

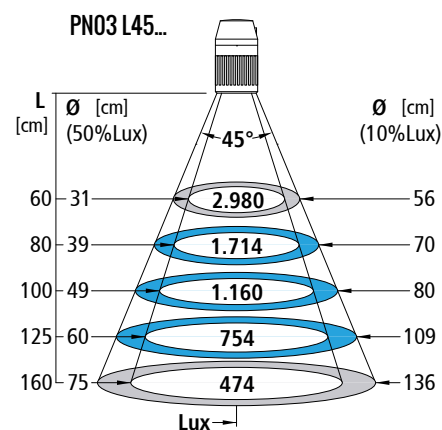
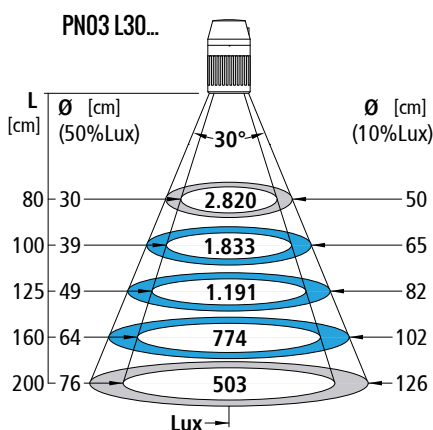

PIK LED 24V-AC/DC

Colori esterni disponibili:

- Nero
- Bianco (-W)

	COD.	Vin	WxLed	CAB.mt	Kg
STANDARD: con Lente 30°	■ PN03 L30-F580-24ACDC	24V AC/DC	1Wx3	CV 02 1,80	1,20
	■ PN03 L30-F680-24ACDC				1,40
OPZIONE: con Lente 45°	□ PN03 L30-F680-24ACDC-W	24V AC/DC	1Wx3	CV 02 1,80	1,40
	■ PN03 L45-F580-24ACDC				1,20
	■ PN03 L45-F680-24ACDC				1,40
	□ PN03 L45-F680-24ACDC-W				1,40

PIK LED 100÷240V-AC

Colori esterni disponibili:

- Nero
- Bianco (-W)

	COD.	Vin	WxLed	CAB.mt	Kg
STANDARD: con Lente 30°	■ PN03 L30-F580-100240AC	100÷240V AC	1Wx3	SP 02 1,80	1,20
	■ PN03 L30-F680-100240AC				1,40
OPZIONE: con Lente 45°	□ PN03 L30-F680-100240AC-W	100÷240V AC	1Wx3	SP 02 1,80	1,40
	■ PN03 L45-F580-100240AC				1,20
	■ PN03 L45-F680-100240AC				1,40
	□ PN03 L45-F680-100240AC-W				1,40

OPTIONAL E RICAMBI

	LENTE 30°	LENTE 45°	VETRO NEUTRO	VETRO AZZURRO	VETRO GIALLO	MORSETTO	STAFFA	BASE MAGNETICA
COD.	LL-IN03-30°	LL-IN03-45°	FIL 50N	FIL 50A	FIL 50G	J C02	J L01/02	J M01

MINI-S SHORT LED

3V-DC
24V-AC/DC
100-240V-AC

1W
6.000°K 40.000 h

RoHS RAEE CONFORMITY



IP54

NIK
LED SECURITY
2015/05 miniS-001



ALTAMENTE PERFORMANTI

- ▣ Fino all'85% di risparmio energetico
- ▣ Basso calore
- ▣ Zero manutenzione
- ▣ Testa orientabile in tecnopolimero con vetro ad alta resistenza
- ▣ Bracci flessibili facilmente regolabili e resistenti alle vibrazioni
- ▣ Resistente ai lubro-refrigeranti
- ▣ Direttive 2006/95/CE, 2004/108/CE e 2006/42/CE come previsto dalla Normativa EN 1387

LOFT
distribution

Sede legale: Via Brisa, 34 - 20015 Parabiago (MI) Italia - Sede operativa: Via Carnia, 2 - 20015 Parabiago (MI) Italia
E-mail: info@loft-srls.it Milo Frison cell. +39 349 1298839 P.IVA: IT 08421750962

MINI-S LED IP54

3V-DC
24V-AC/DC
100÷240V-AC

1W
6.000°K **40.000 h**

RoHS RAEE CONFORMITY



MINI-S LED 3V-DC/350mA, 1W

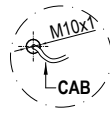

MN01 L-F275-3DC-SB

OPTIONAL

[Vin] ≤ → 3V-DC

COD. **LD2-1024-P1**

[Vin] 24V-AC/DC

COD. **LN-0104-P5**

[Vin] 100÷240V-AC

MINI-S LED 24V-AC/DC, 1W

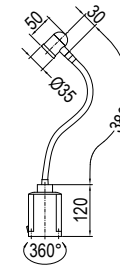
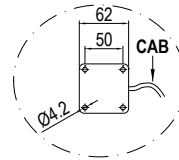

MN01 L-F380-24ACDC

MINI-S LED 100÷240V-AC, 1W

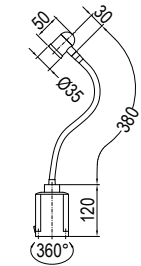
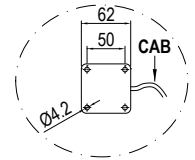

MN01 L-F380-100240AC

1 versione senza base:

- 3V-DC/350mA con cavo bipolare
- in opzione: alimentatore esterno da 24V-AC/DC o da 100÷240V-AC

2 versioni con base:

- 24V-AC/DC con alimentatore integrato nella base e cavo bipolare
- 100÷240V-AC con alimentatore integrato nella base e cavo con spina Euro 10A

Accessori opzionali (versione con base):
morsetto, staffa e base magnetica di fissaggio

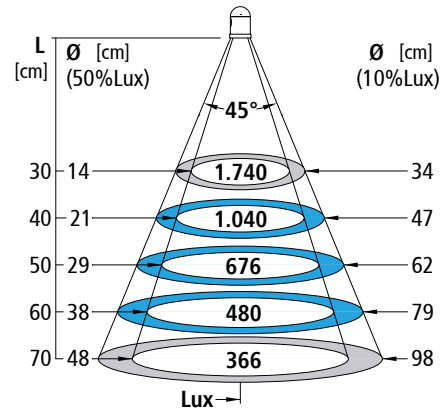

MINI-S LED 3V-DC/350mA

24V-AC/DC 100÷240V-AC

COD.	Vin	WxLed	CAB.mt	Kg
STANDARD				
MN01 L-F275-3DC-SB	3V-DC 350mA	1Wx1	CV 02 1.00	0,18
OPTIONAL: Alimentatori esterni				
LD2-1024-P1	24V AC/DC			0,03
LN-0104-P5	100÷240V AC			0,04

MINI-S LED 24V-AC/DC

COD.	Vin	WxLed	CAB.mt	Kg
STANDARD				
MN01 L-F380-24ACDC	24V AC/DC	1Wx1	CV 02 1.80	0,43

MINI-S LED 100÷240V-AC

COD.	Vin	WxLed	CAB.mt	Kg
STANDARD				
MN01 L-F380-100240AC	100÷240V AC	1Wx1	SP 04 1.80	0,43

OPTIONAL

MORSETTO
MN01 L-F380



COD.

J C03

STAFFA
MN01 L-F380



J L05

BASE MAGNETICA
MN01 L-F380



J M01

MINI-F ^{FIX} LED

24V-AC/DC
100-240V-AC

3W
6.000°K 40.000 h

RoHS RAEE CONFORMITY



IP65

NIK
LED SECURITY
2015/05 miniF-001



MN03 L40-F500-24ACDC
MN03 L40-F500-100240AC

MN03 L40-F700-24ACDC
MN03 L40-F700-100240AC

ALTAMENTE PERFORMANTI

- ▣ Fino all'85% di risparmio energetico
- ▣ Basso calore
- ▣ Zero manutenzione
- ▣ Testa orientabile in alluminio con vetro ad alta resistenza
- ▣ Bracci flessibili facilmente regolabili e resistenti alle vibrazioni
- ▣ Resistente ai lubro-refrigeranti
- ▣ Direttive 2006/95/CE, 2004/108/CE e 2006/42/CE come previsto dalla Normativa EN 1387

MINI-F LED IP65

24V-AC/DC
100÷240V-AC

3W
6.000°K **40.000 h**

RoHS RAEE CONFORMITY



MINI-F LED 24V-AC/DC, 3W

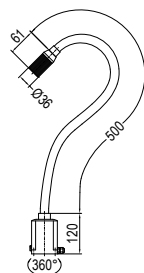
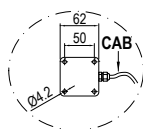

MN03 L40-F500-24ACDC

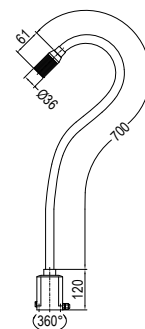

MN03 L40-F700-24ACDC

MINI-F LED 100÷240V-AC, 3W

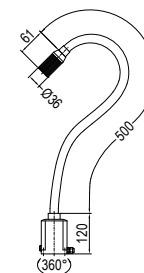
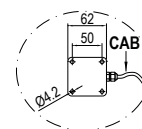

MN03 L40-F500-100240AC

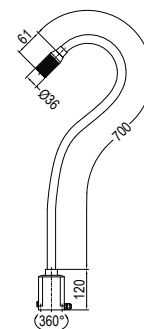

MN03 L40-F700-100240AC

2 versioni di alimentazione:

- **24V-AC/DC** con alimentatore integrato nella base e cavo bipolare
- **100-240V-AC** con alimentatore integrato nella base e cavo con spina Euro 10A

Accessori opzionali:

morsetto, staffa e base magnetica di fissaggio

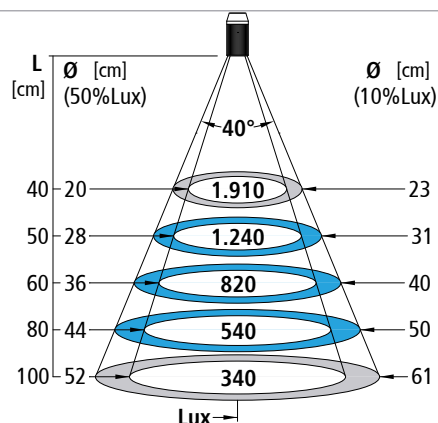

MINI-F LED 24V-AC/DC

COD.	Vin	WxLed	CAB. mt	Kg
STANDARD				
MN03 L40-F500-24ACDC	24V AC/DC	3Wx1	CV 02	0.75
MN03 L40-F700-24ACDC			1.80	1.00

MINI-F LED 100÷240V-AC

COD.	Vin	WxLed	CAB. mt	Kg
STANDARD				
MN03 L40-F500-100240AC	100-240V AC	3Wx1	SP 04	0.75
MN03 L40-F700-100240AC			1.80	1.00

OPTIONAL

MORSETTO
MN01 L-F380



COD.

J C03

STAFFA
MN01 L-F380



J L05

BASE MAGNETICA
MN01 L-F380



J M01

MINI-Z ^{ZOOM} LED

24V-AC/DC
100-240V-AC

3W
6.000°K 40.000 h

RoHS RAEE CONFORMITY



IP65

NIK
LED SECURITY
2015/05 miniZ-001



MN03 LZ-F700-24ACDC
MN03 LZ-F700-100240AC

ALTAMENTE PERFORMANTI

- ▣ Fino all'85% di risparmio energetico
- ▣ Basso calore
- ▣ Zero manutenzione
- ▣ Testa orientabile in alluminio ad angolo variabile con vetro ad alta resistenza
- ▣ Braccio flessibile facilmente regolabile e resistente alle vibrazioni
- ▣ Resistente ai lubro-refrigeranti
- ▣ Direttive 2006/95/CE, 2004/108/CE e 2006/42/CE come previsto dalla Normativa EN 1387



Sede legale: Via Brisa, 34 - 20015 Parabiago (MI) Italia - Sede operativa: Via Carnia, 2 - 20015 Parabiago (MI) Italia
E-mail: info@loft-srls.it Milo Frison cell. +39 349 1298839 P.IVA: IT 08421750962

MINI-Z LED IP65

24V-AC/DC
100÷240V-AC

3W
6.000°K 40.000 h

RoHS RAEE CONFORMITY



ZOOM:

angolo illuminazione variabile da 10° a 80°
2 versioni di alimentazione:

- 24V-AC/DC con alimentatore integrato nella base e cavo bipolare
- 100-240V-AC con alimentatore integrato nella base e cavo con spina Euro 10A

Accessori opzionali:

morsetto, staffa e base magnetica di fissaggio

MINI-Z LED 24V-AC/DC, 3W

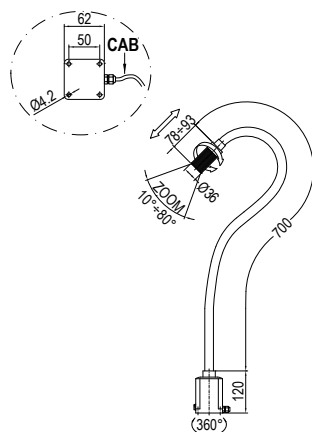

MN03 LZ-F700-24ACDC

MINI-Z LED 100-240V-AC, 3W

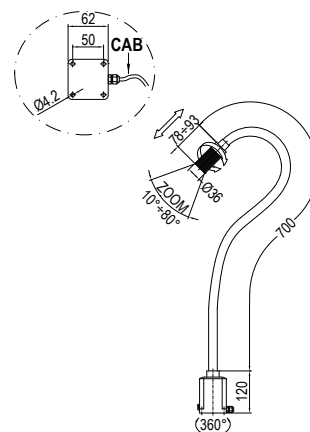

MN03 LZ-F700-100240AC

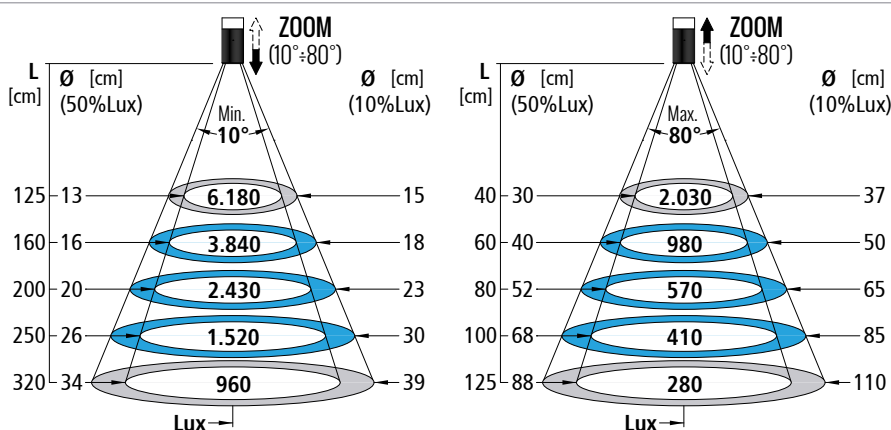

MINI-Z LED 24V-AC/DC

COD.	Vin	WxLed	CAB. mt	Kg
STANDARD				
MN03 LZ-F700-24ACDC	24V AC/DC	3Wx1	CV 02 1,80	1,10

MINI-Z LED 100-240V-AC

COD.	Vin	WxLed	CAB. mt	Kg
STANDARD				
MN03 LZ-F700-100240AC	100-240V AC	3Wx1	SP 04 1,80	1,10

OPTIONAL

MORSETTO
MN01 L-F380



COD.

J C03

STAFFA
MN01 L-F380



J L05

BASE MAGNETICA
MN01 L-F380



J M01

LEDY LED

24V-DC

7,5W - 15W

22,5W

6.000°K

30.000 h

RoHS RAEE CONFORMITY



IP67

ø26/ø28

NIK
LED SECURITY

2015/05

ledy-001

LEDY072A-24DC
LEDY072G-24DC

LEDY072A-24DC
LEDY072G-24DC

A RICHIESTA

LEDY073A-24DC
LEDY073G-24DC

Piccolo foro con valvola
adesiva anti-condensa



Connettore dritto
con cavo 5mt



Connettore a 90°
con cavo 5mt



Connettore M12
a 4-poli

ALTAMENTE PERFORMANTI

- ▣ Fino all'85% di risparmio energetico
- ▣ Basso calore
- ▣ Zero manutenzione
- ▣ Struttura in alluminio, copertura anti-riflesso e tubo esterno in acrilico o vetro
- ▣ Ideale per applicazioni antinfortunistiche su mini-macchine e spazi ristretti
- ▣ Resistente ai lubro-refrigeranti
- ▣ Direttive 2006/95/CE, 2004/108/CE e 2006/42/CE come previsto dalla Normativa EN 1387

LOFT
distribution

Sede legale: Via Brisa, 34 - 20015 Parabiago (MI) Italia - Sede operativa: Via Carnia, 2 - 20015 Parabiago (MI) Italia
E-mail: info@loft-srls.it Milo Frison cell. +39 349 1298839 P.IVA: IT 08421750962

LEDY LED IP67

24V-DC

7,5W - 15W

22,5W (A RICHIESTA)

6.000°K

30.000 h

RoHS RAEE CONFORMITY



LEDY071 ACRILICO, 24V-DC, 7,5W

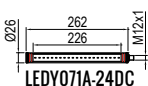

LEDY071 VETRO, 24V-DC, 7,5W

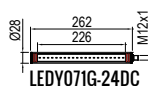

LEDY072 ACRILICO, 24V-DC, 15W

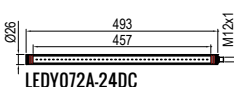

LEDY072 VETRO, 24V-DC, 15W

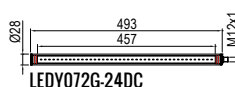

(A RICHIESTA) LEDY073 ACRILICO, 24V-DC, 22,5W

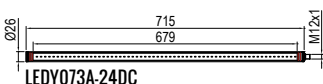

(A RICHIESTA) LEDY073 VETRO, 24V-DC, 22,5W

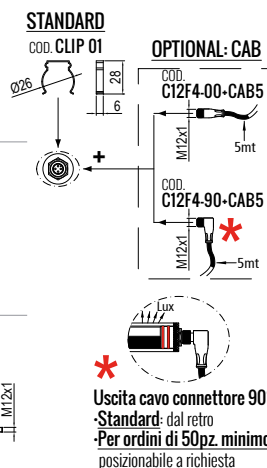
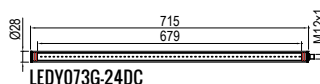

3 versioni di potenza e lunghezza:

- LEDY071 con 1 Set di Led per 7,5W
- LEDY072 con 2 Set di Led per 15W
- LEDY073 (a richiesta) con 3 Set di Led per 22,5W

Standard:

- alimentatore 24V-DC integrato
- tubo esterno in acrilico (vetro in opzione)
- connettore maschio M12 a 4 poli
- 1 coppia di clip di fissaggio

2 opzioni di cavo:

- connettore dritto con cavo 5mt
- connettore a 90° con cavo 5mt *

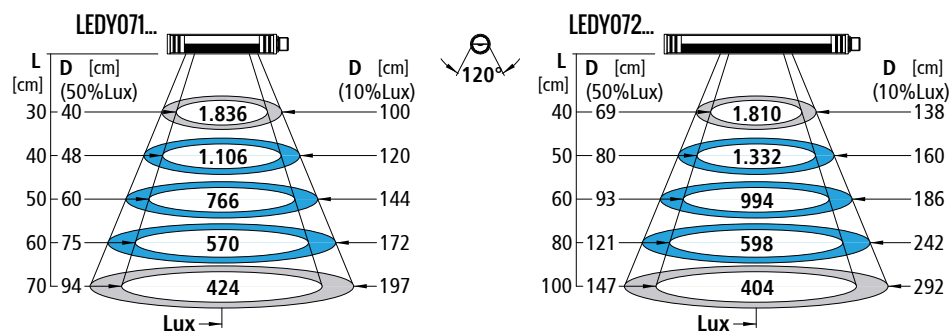

LEDY071 7,5W 24V-DC

COD.	Vin	W	CAB. mt	Kg
STANDARD: con tubo in acrilico				
LEDY071A-24DC	24V-DC	7,5W	Optional	0,16
OPZIONE: con tubo in vetro				
LEDY071G-24DC	24V-DC	7,5W	Optional	0,21

LEDY072 15W 24V-DC

COD.	Vin	W	CAB. mt	Kg
STANDARD: con tubo in acrilico				
LEDY072A-24DC	24V-DC	15W	Optional	0,27
OPZIONE: con tubo in vetro				
LEDY072G-24DC	24V-DC	15W	Optional	0,37

LEDY073 (A RICHIESTA) 22,5W 24V-DC

COD.	Vin	W	CAB. mt	Kg
STANDARD: con tubo in acrilico				
LEDY073A-24DC	24V-DC	22,5W	Optional	0,38
OPZIONE: con tubo in vetro				
LEDY073G-24DC	24V-DC	22,5W	Optional	0,52

STANDARD E RICAMBI

TUBO ACRILICO LEDY071	TUBO VETRO LEDY071	TUBO ACRILICO LEDY072	TUBO VETRO LEDY072	TUBO ACRILICO LEDY073	TUBO VETRO LEDY073	CLIP DI FISSAGGIO (Nr.1 - 2 PEZZI)
COD. JTL 252A	JTL 252G	JTL 483A	JTL 483G	JTL 705A	JTL 705G	CLIP01

OPTIONAL: CAB

CONNETTORE DRITTO CON CAVO 5MT	CONNETTORE 90° CON CAVO 5MT
COD. C12F4-00-CAB5	C12F4-90-CAB5

WIDE1 LED

24V-AC/DC
100-240V-AC

20W - 40W
6.000°K 40.000 h

RoHS RAEE CONFORMITY



IP67

NIK
LED SECURITY

2015/05 wide1-001

WIDE1-201C-24ACDC
WIDE1-201P-24ACDC
WIDE1-201P-100240AC

WIDE1-202C-24ACDC
WIDE1-202P-24ACDC
WIDE1-202P-100240AC



Versione WIDE1 P
con Pressa-cavo



Connettore dritto
con cavo 5mt



Connettore a 90°
con cavo 5mt



Versione WIDE1 C con
Connettore M12 a 4-poli

ALTAMENTE PERFORMANTI

- ▣ Fino all'85% di risparmio energetico
- ▣ Basso calore
- ▣ Zero manutenzione
- ▣ Struttura in alluminio
- ▣ Dotata di vetro ad alta resistenza e griglia di lenti anti-irritazione per gli occhi
- ▣ Resistente ai lubro-refrigeranti
- ▣ Direttive 2006/95/CE, 2004/108/CE e 2006/42/CE come previsto dalla Normativa EN 1387

LOFT
distribution

Sede legale: Via Brisa, 34 - 20015 Parabiago (MI) Italia - Sede operativa: Via Carnia, 2 - 20015 Parabiago (MI) Italia
E-mail: info@loft-srls.it Milo Frison cell. +39 349 1298839 P.IVA: IT 08421750962

WIDE1 LED IP67

24V-AC/DC
100÷240V-AC

20W - 40W
6.000°K **40.000 h**

RoHS RAEE CONFORMITY



WIDE1 C 24V-AC/DC

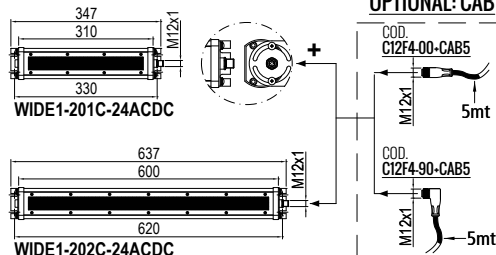

WIDE1 P 24V-AC/DC WIDE1 P 100÷240V-AC

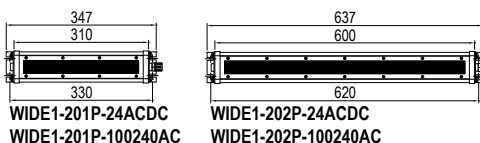

2 versioni di potenza e lunghezza:

- **WIDE1-201** con 1 Set di Led (Nr.48) per una potenza totale di **20W**
- **WIDE1-202** con 2 Set di Led (Nr.96) per una potenza totale di **40W**

2 versioni di alimentazione:

- **24V-AC/DC** con **cablaggio a scelta** tra Connettore M12 a 4 poli (cavo opzionale) o Pressa-cavo con cavo tripolare
- **100÷240V-AC** con **Pressa-cavo** e cavo con spina Schuko

Standard: alimentatore integrato e supporti di fissaggio basculanti

Accessori opzionali: connettore dritto o a 90° con cavo 5mt (per lampade WIDE1 C con Connettore) e staffe di fissaggio

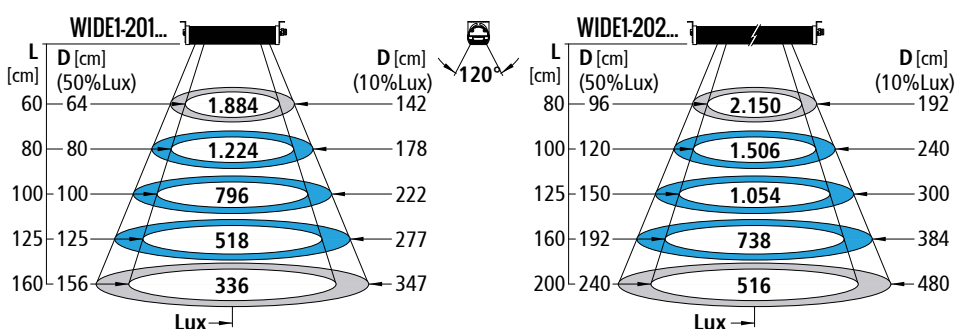

WIDE1 24V-AC/DC 20W - 40W	COD.		Vin	W	CAB. mt	Kg
	WIDE1 C: Connettore					
	WIDE1-201C-24ACDC	WIDE1-202C-24ACDC	24V AC/DC	20W / 40W	Optional	1,60 / 2,50
	WIDE1 P: Pressa-cavo					
	WIDE1-201P-24ACDC	WIDE1-202P-24ACDC	24V AC/DC	20W / 40W	CV 03 / 1,80	1,60 / 2,50

WIDE1 100÷240V-AC 20W - 40W	COD.		Vin	W	CAB. mt	Kg
	WIDE1 P: Pressa-cavo					
	WIDE1-201P-100240AC	WIDE1-202P-100240AC	100÷240V AC	20W / 40W	SP 02 / 1,80	1,60 / 2,50

OPTIONAL

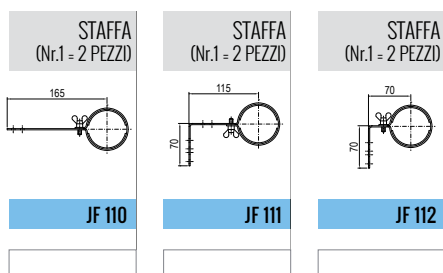

OPTIONAL: CAB (WIDE1 C)

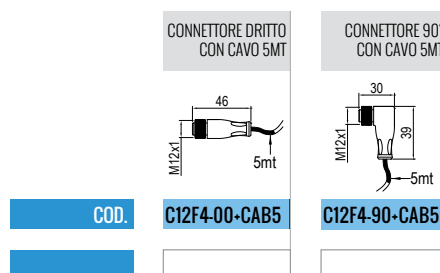



Sede legale: Via Brisa, 34 - 20015 Parabiago (MI) Italia
Sede operativa: Via Carnia, 2 - 20015 Parabiago (MI) Italia
E-mail: info@loft-srls.it
Milo Frison cell. +39 349 1298839
P.IVA: IT 08421750962